



JFR Series FMCW Radar Level Transmitter



www.fine-tek.com



PRODUCT INTRODUCTION

FMCW Radar level transmitter is a non contact measuring device, which is suitable for high temp., high pressure, and corrosive applications. It is easy to install and free of maintenance, especially for the high accuracy requirement environment.

PRINCIPLE

FMCW radar adopts a high frequency signal, which is emitted via an antenna and swipes frequency increment by 0.5GHz during the measurement, reflected by the target surface and received at a time delay. The frequency difference, which is calculated from the transmitting frequency and the received frequency, which is directly proportional to the measured distance (or material surface).

The frequency difference then is processed by Fast Fourier Transformation (FFT) to identify the signal in Intermedium Frequency (IF). This FMCW radar is innate with signal / noise enhancement and filtering of echo-back via Phase-Lock Loop (PLL) circuit that is the best solution for complex environment and high accuracy measurement.

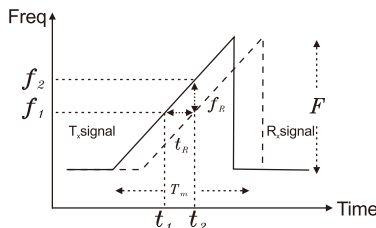

Design formula

$$\text{Slop} = \frac{F}{T_m} = \frac{f_2}{t_r} = \frac{f_1}{\frac{2R}{c}} \quad t_r = \frac{2R}{c}$$

$$R = \frac{F_R \times c \times T_m}{2F}$$

LINEARITY DIAGRAM

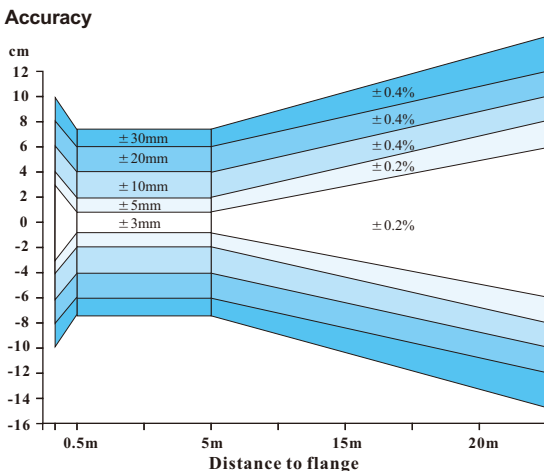

FEATURES

- Non contact measuring
- Corrosive and toxic liquid, hydrocarbons, slurries
- Not affected by specific gravity, pressure, temperature, viscosity, foam, and dust
- 5 digits LCM display
- Indicate signal wave inside the silo.
- Selection of Different Measurement unit(m, cm, mm, inch, ft, %, mA)
- Measuring distance and actual level.
- Language selection of traditional Chinese, simplified Chinese, English.
- 4-20mA/ 4 lead wires
- Modbus RS-485 to enhance isolation and easy for remote control.
- CE standards for isolation(EFT 2000V, B class or better)
- Suitable for mid-range signal
- 4mA, 20mA output
- Set functions to the continuous measuring device via FAS software.
- Isolated circuit design.
- 10GHz JFR1 series could measure liquid material.
- 26GHz JFR2 series could measure all kinds of material.

TEST STANDARDS

- High voltage : IEC60947-2
- Isolated resistance : IEC60092-504
- Power supply change : IEC60092-504
- Power supply failure : IEC60092-504
- Electrical burst testing : IEC61000-4-4
- Voltage DIPS : IEC61000-4-11
- Humidity : IEC60068-2-30
- High/Low temperature test : IEC60068-2-38
- IP protection rating : IEC60529

SPECIFICATION (26GHz 4-wire)

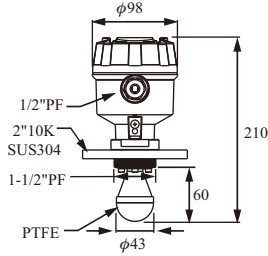
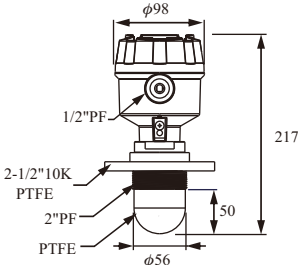
Dimensions (Unit:mm)		
Model	JFR-204	JFR-214
Medium	General liquid and solid	General liquid /suitable for acid and alkaline in liquid
Min. Dielectric constant (solid)	1.5	
Min. Dielectric constant (liquid)	1.4	
Measuring range	Liquid 30m Solid 20m	Liquid 30m
Accuracy	± 3 mm	
Repeatability	± 1 mm	
Digital communication	RS485 (Isolated)	
Ambient temperature	-40~90 °C	
Operating temperature	-40~200 °C	
Operating pressure	0~40 bar	
Frequency	K Band	
Analog output	4~20mA / 4 Wire	
Protection rating	IP67	
Power supply	9.5~30Vdc	
Local display	5 digits LCM display	
Housing material	Aluminum	
Antenna type	Horn (43D)	Lens (56D)
Half-power beam width	$\pm 9^\circ$	
Antenna material	SUS316+PTFE	PTFE
Blind distance	500mm	

SPECIFICATION (26GHz 4-wire)

Dimensions (Unit:mm)			
	Model	JFR-224	JFR-234
Medium	General liquid and solid		
Suitable For	Long distance measurement	Super distance measurement	Corrosion type acid and alkaline liquid
Min. Dielectric constant (solid)	1.5		
Min. Dielectric constant (liquid)	1.4		
Measuring range	Liquid 30m Solid 20m	Liquid 70m Solid 50m	Liquid 20m Solid 15m
Accuracy	± 3 mm	± 3mm @distance<40m ± 0.01%F.S. @distance>40m	± 3 mm
Repeatability	± 1 mm		
Digital communication	RS485 (Isolated)		
Ambient temperature	-40~90 °C		
Operating temperature	-40~200 °C		
Operating pressure	0~40 bar		
Frequency	K Band		
Analog output	4~20mA / 4 Wire		
Protection rating	IP67		
Power supply	9.5~30 Vdc		
Local display	5 digits LCM display		
Housing material	Aluminum		
Antenna type	High gain horn (100)	High gain horn (140)	Lens(43DS)
Half-power beam width	± 5°	± 3°	± 10°
Antenna material	SUS 316		PTFE
Blind distance	500 mm		

P.S. For JFR-224 and JFR-234, customer can connect the compressed air with 1/8"PT thread connector to avoid dust adhered.

SPECIFICATION (10GHz 4-wire)

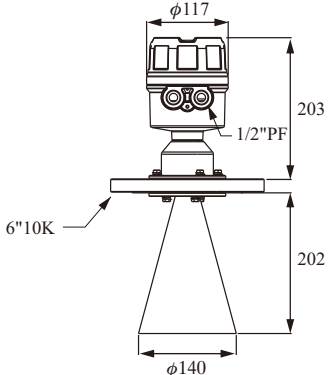
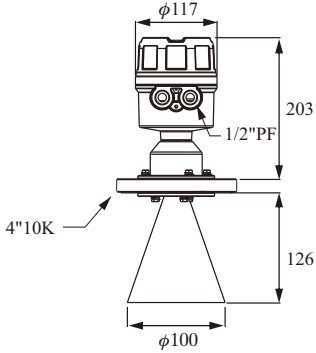
Dimensions (Unit:mm)		
Model	JFR-10	JFR-11
Medium	General liquid, corrosion liquid (coating)	
Min. dielectric constant	2.5	
Accuracy (1m~5m)	± 5mm	
Repeatability	± 1mm	
Measuring range	30m	20m
Digital communication	RS485(Isolated)	
Ambient temperature	-40~70°C	
Operating temperature	-40~200°C	
Operating pressure	0~40 bar	
Frequency	X Band	
Analog output	4~20mA / 4 Wire	
Power consumption	100mA/ 24Vdc	
Protection rating	IP65	
Power supply	24Vdc ± 10%	
Local display	5 digits LCM display	
Housing material	Aluminum	
Antenna type	Horn(140D)	Horn(100D)
Half-power beam width	± 10°	± 8°
Antenna material	SUS 316/ ETFE Coating	
Sampling rate	1 sec.	
Blind distance	500 mm	

SPECIFICATION (10GHz 4-wire)

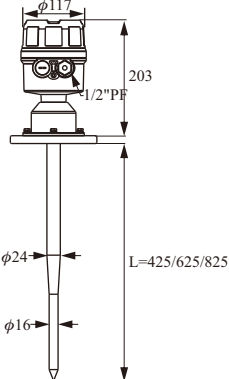
Dimensions (Unit:mm)	
Model	JFR-13F / JFR-14F/ JFR-15F
Medium	General liquid, corrosion liquid (coating)
Min. dielectric constant	4
Accuracy (1m~5m)	± 20mm
Repeatability	± 1mm
Measuring range	10m
Digital communication	RS485(Isolated)
Ambient temperature	-40~70°C
Operating temperature	-40~150°C
Operating pressure	0~16 bar
Frequency	X Band
Analog output	4~20mA/ 4 Wire
Power consumption	100mA/ 24Vdc
Protection rating	IP65
Power supply	24Vdc ± 10%
Local display	5 digits LCM display
Housing material	Aluminum
Antenna type	Rod antenna
Half-power beam width	± 11°
Antenna material	PTFE
Sampling rate	1sec.
Blind distance	600mm

WIRING/CALIBRATION

WIRING INFORMATION

RS485 wiring

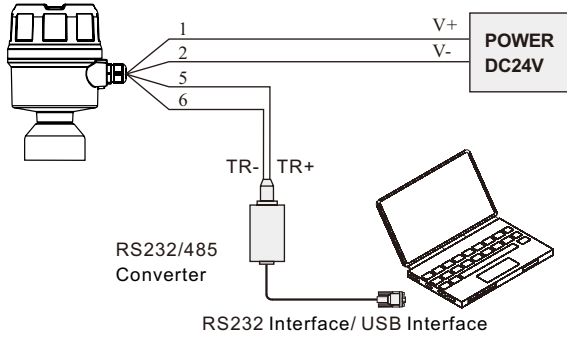

JFR Series and Indicator(External Power)

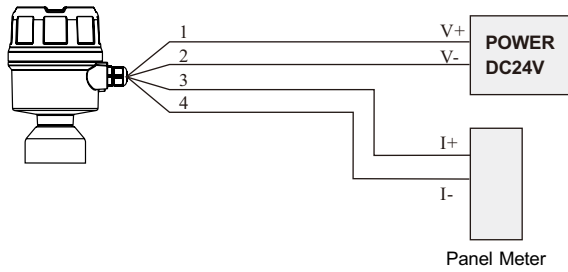

JFR Series and Indicator(Powered by panel meter)



WIRING DIAGRAM

JFR-1

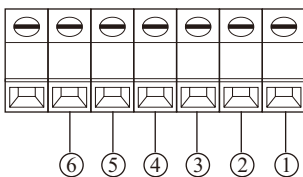

JFR-2

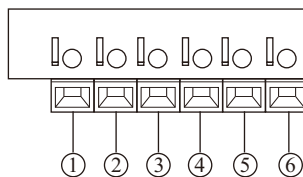

- ① Power Supply: V+
- ② Power Supply: V-
- ③ Analog Output: I+ (4~20mA)
- ④ Analog Output: I- (4~20mA)
- ⑤ Communication: TR+ (RS485)
- ⑥ Communication: TR- (RS485)

CALIBRATION

Two ways to calibrate the JFR Series:

1. With display/adjustment module
2. By PC based FAS software

Adjustment module is an adjustment tool with 4 buttons to click on. It also has a transparent window to allow display reading.

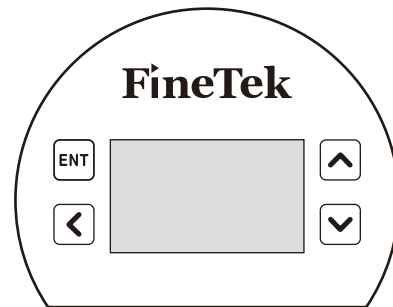

5 digits LCM display

[ENT] Button

- Enter Edit status
- Confirm Edit
- Confirm parameter modification

[<] Button

- Select Edit
- Select parameter
- Parameter modification

[^] Button

- Return
- Cancel

[>] Button

- Increase
- Select

PARAMETER SETTING

Measurement bench-mark starts at contact surface of connection.

- ① Low level calibration
- ② High level calibration
- ③ Blind Distance
- ④ Measuring Distance Setup

Note: Be aware of blind distance when measuring material high level.(Shown in ③)

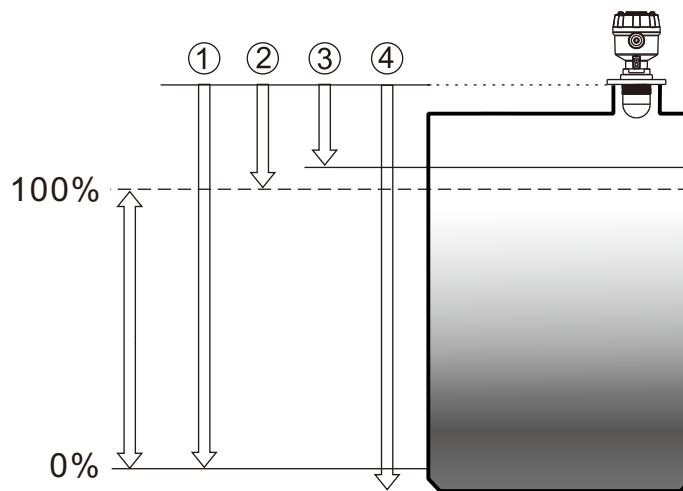

SOFTWARE SETUP CALIBRATION

Software Setup Calibration(FAS)

FAS calibration software can be utilized with JFR Series via RS485/RS232 to allow tank data reading and setup from PC.

Parameter Description

Low Point: Low point(4mA), measuring range from flange to low level.

High Point: High point(20mA), measuring range from flange to high level.

Blind Area: Blind distance, distance starts from flange surface.

Max. Distance: Measuring range between low point and high point.

FAS Operation Instruction

1. Turn on FAS software
2. Go to Address, then choose 9600, COM5 from baudrate
3. Click on Connect.
4. Press "Stop Sync" to change parameter.
5. Press "GetFFT" to read wave reflection diagram.
Press "Stop Sync" to change preset parameter.

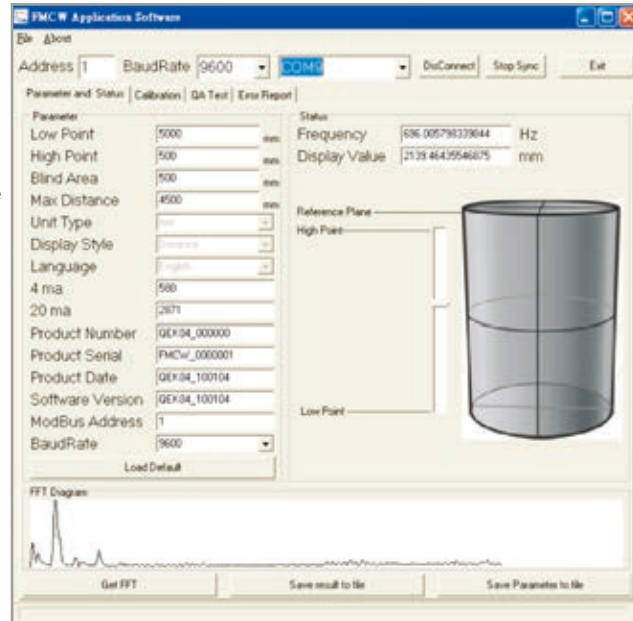

INSTALLATION

1. Installation in the extension tube

1-1 JFR-13 series installation with extension tubes inside the tank, extension tube length and diameter is required to meet the requirements.

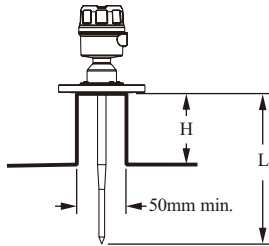

Model	Antenna length L	Extension tube length
JFR-13F	425 mm	$H \leq 160$
JFR-14F	625 mm	$H \leq 360$
JFR-15F	825 mm	$H \leq 560$

1-2 JFR-10 and JFR-11 series horn antenna can be hidden in the extension tube the recommendation of the tube diameter D and length L are shown in the table.

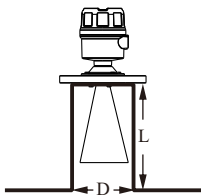

Model	Diameter D (mm)	Length L (mm)
JFR-10	$D > 140$	$L \leq 270$
JFR-11	$D > 100$	$L \leq 140$

1-3 JFR-204 can be hidden in the extension tube, the recommendation of the tube diameter D and length L are shown in the table.

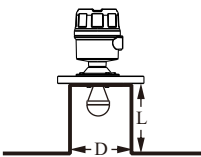

Diameter D (mm)	Length L (mm)
50	$L \leq 160$
70	$L \leq 220$
85	$L \leq 260$
110	$L \leq 330$

1-4 JFR-214 can be hidden in the extension tube, the recommendation of the tube diameter D and length L are shown in the table.

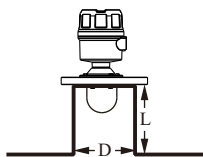

Diameter D (mm)	Length L (mm)
70	$L \leq 60$
85	$L \leq 100$
110	$L \leq 170$

1-5 JFR-224 and JFR-234 can be hidden in the extension tube, the recommendation of the tube diameter D and length L are shown in the table.

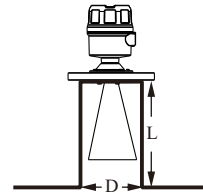

Model	Diameter D (mm)	Length L (mm)
JFR-224	$D > 100$	$L \leq 140$
JFR-234	$D > 140$	$L \leq 270$

1-6 JFR-244 can be hidden in the extension tube, the recommendation of the tube diameter D and length L are shown in the table.

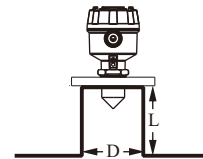

Diameter D (mm)	Length L (mm)
2"	$L \leq 100$
2-3/4"	$L \leq 150$
3-3/8"	$L \leq 230$
4-3/8"	$L \leq 380$

1-7 Installation recommendations are as follows :

- Antenna installation angle to be perpendicular to the Horizontal.
- JFR installation position with the drum wall suggestions Are as follows :
Installation location A should be less than $1/6D$
Range with A relation is as follows :
a. $H < 10m$, $A > 300mm$
b. $10m < H < 20m$, $A > 600mm$
c. $H > 20m$, $A > 900mm$

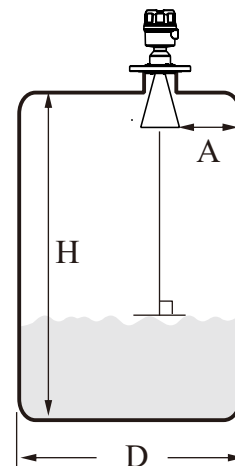

INSTALLATION

2. Radar installation should not be too close to the drum wall, avoid the drum wall attachment material reflection interference.

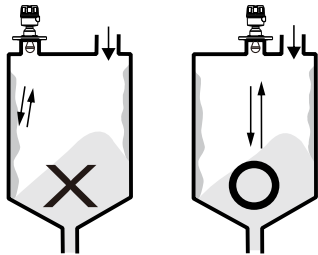

3. Radar installation not too close to the drum bracket to avoid reflection is incorrect

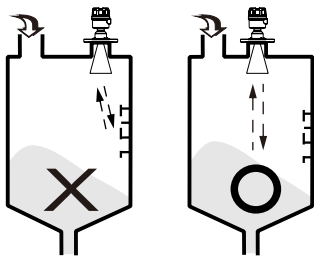

4. When obstructions inside the tank, tank be fitted with effectors, steer clear of the error echo reflected to the receiver, causing radar miscalculation.

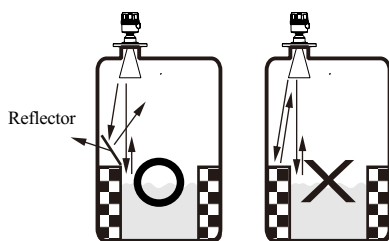

5. Outdoor installation should take shade or rain-proof measures.

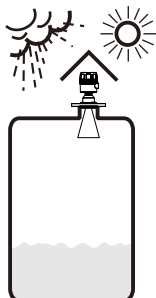

6. If drum internal agitator will have a strong vortex and foam, drum must increase waveguide, the upper waveguide drill vent holes to ensure the correctness of the measured value.

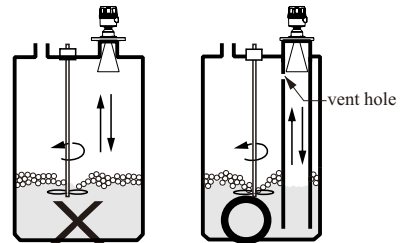

7. Installation should be avoided in the feed inlet position, avoid material interference or obstacles interference.

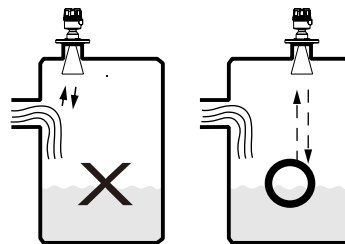

8. Installation should be avoided in the top center of the arch or round barrel will cause multiple echo reflections.

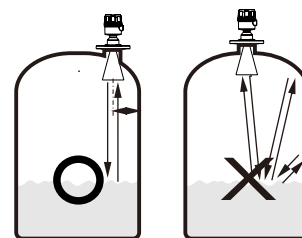

ORDERING INFORMATION(26GHz)

JFR-2 - - - 0

Antenna type

- 0: Horn(43D)
- 1: Lens(56D)
- 2: High gain Horn(100D)
- 3: High gain Horn(140D)
- 4: Lens(43DS)

Wiring

- 4: 4-Wire

Accuracy

- P: ±3mm A: ±5mm B: ±10mm

Connection type

- 0: Flange
- 1: Thread

Connection specification

Size for flange or screw	
E: 1-1/2"(40A)	I: 4"(100A)
F: 2" (50A)	J: 5"(125A)
G: 2-1/2"(65A)	K: 6"(150A)
H: 3" (80A)	S: Others

Pressure range or other	
M: 5kg/cm ² JIS	W: PN10 (10Bar)
N: 10kg/cm ² JIS	X: PN16 (16Bar)
O: 150Lbs ANSI	Y: PN25 (25Bar)
P: 300Lbs ANSI	Z: PN40 (40Bar)
R: PF	S: Others
U: NPT	

- (1)JFR-204 thread connection 1-1/2" only
- (2)JFR-214 thread connection 2" only
- (3)JFR-224 thread connection 1-1/2" only
- (4)Please do check Radar antenna can be direct fitted in flange connection and nozzle

Below is the suggestion

Type	Opening	Flange size
JFR-214	56mm	2-1/2"
JFR-224	100mm	4"
JFR-234	140mm	6"
JFR-244	44mm	2"

Flange material

- Metal 0: SUS304 5: SS41 zinc coating 6: SUS316
- Plastic P: PP E: PTFE

ORDERING INFORMATION(10GHz)

JFR-1 - - 0 - 0 - R01

Type

- 0: Horn Antenna Type3
(Length 202mm, opening 140mm) Standard
- 1: Horn Antenna Type2
(Length 126mm, opening 100mm)
- 3: Rod Antenna
(Length 425mm) Standard
- 4: Rod Antenna
(Length 625mm)
- 5: Rod Antenna
(Length 825mm)

Material

- 0: SUS304---Horn Antenna
- 6: SUS316---Horn Antenna
- E: ETFE-----Horn Antenna with ETFE coating
- F: PTFE-----Rod Antenna

Accuracy

- A: ± 5mm B: ± 10mm
- C: ± 20mm D: ± 30mm

Flang connection

Size for flange or screw		Pressure range or other	
G: 2-1/2"(65A)	I: 4"(100A)	M: 5kg/cm ² JIS	W: PN10 (10Bar)
H: 3" (80A)	J: 5"(125A)	N: 10kg/cm ² JIS	X: PN16 (16Bar)
	K: 6"(150A)	O: 150Lbs ANSI	Y: PN25 (25Bar)
	S: Others	P: 300Lbs ANSI	Z: PN40 (40Bar)
			S: Others

※ Please do check Radar antenna can be direct fitted in flange connection and nozzle
Below is the suggestion

(1) Horn Antenna

Type	Opening	Flange size
Type3	140mm	6"
Type2	100mm	4"

(2) Rod Antenna

Minimum size of flange is 2-1/2"

Flange material

- Metal 0: SUS304 5: SS41 zinc coating 6: SUS316
- Plastic P: PP E: PTFE

Global Network

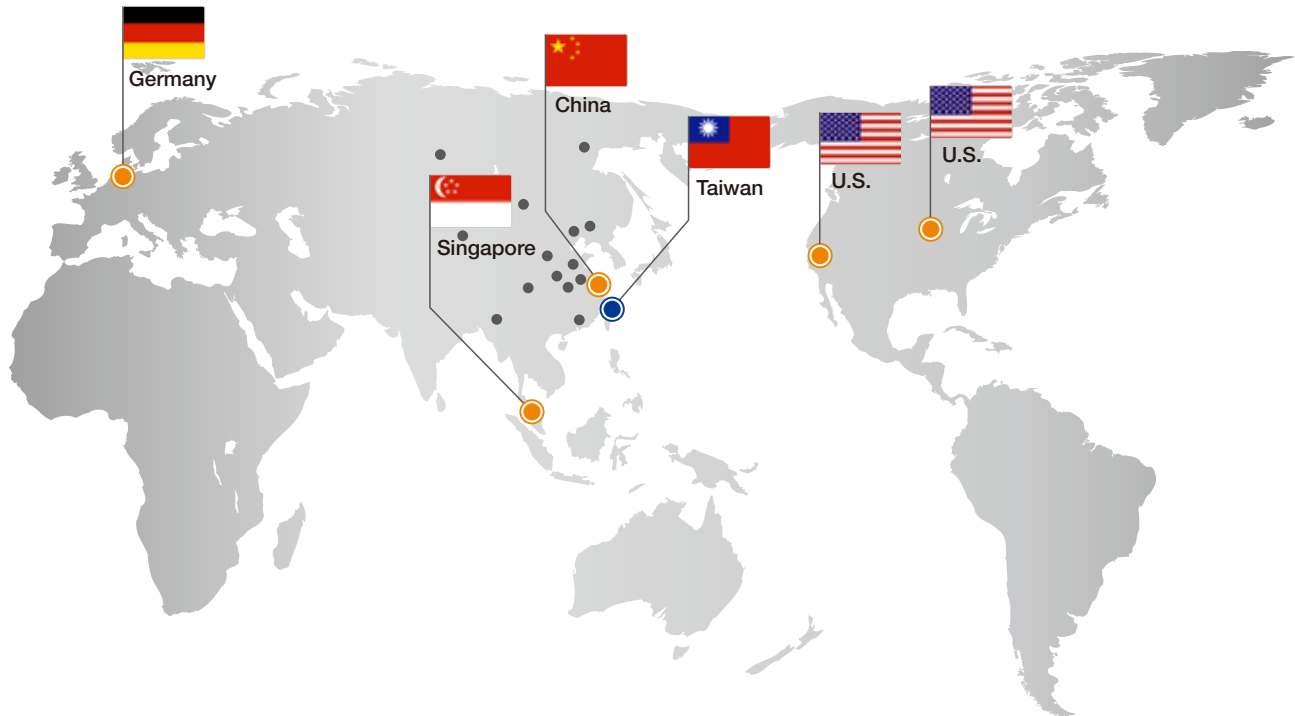

■ Asia

● Taiwan

FINETEK CO., LTD. - Taipei Head Quarter
No.16, Tzuchiang St., Tucheng Industrial Park
New Taipei City 236, Taiwan
TEL: 886-2-2269-6789
FAX: 886-2-2268-6682
EMAIL: info@fine-tek.com

FINETEK CO., LTD. - I-Lan Factory
TEL: 886-3-990-9669
FAX: 886-3-9909659

FINETEK CO., LTD. - Taichung Brance
TEL: 886-4-2337-0825
FAX: 886-4-2337-0836

FINETEK CO., LTD. - Kaohsiung Branch
TEL: 886-7-333-6968
FAX: 886-7-536-8758

● China

FINE AUTOMATION CO., LTD. - Shanghai Factory
No.451 DuHui Rd, MinHang District, Shanghai,
China 201109
TEL: 86-21-6490-7260
FAX: 86-21-6490-7276
EMAIL: info.sh@fine-tek.com

● Singapore

FINETEK PTE LTD. - Singapore Office
No. 60 Kaki Bukit Place, #07-06 Eunos
Techpark 2 Lobby B, Singapore 415979
TEL: 65-6452-6340
FAX: 65-6734-1878
EMAIL: info.sg@fine-tek.com

■ North America

● California, U.S.

APLUS FINETEK SENSOR INC. - US Office
355 S. Lemon Ave, Suite D, Walnut,
CA 91789
TEL: 1 909 598 2488
FAX: 1 909 598 3188
EMAIL: info@aplusfine.com

● Illinois, U.S.

APLUS FINETEK SENSOR INC.
TEL: 1 815 632-3132
FAX: 1 815 716 8464
EMAIL: info@aplusfine.com

■ Europe

● Germany

FineTeK GmbH - Germany Office
Frankfurter Str. 62, OG D-65428
Ruesselsheim, Germany
TEL: +49-(0)6142-17608-0
FAX: +49-(0)6142-17608-20
EMAIL: info@fine-tek.de



Distributor: